

Splash Fabric Display (STRAIGHT)

341000 thru 341011
338014, 338015, 338016

Item #	Graphic	Quads used	**PLATES
341000/341002	6FT TT FACE	4	14
341001/341003	6FT TT WRAP	4	14
341004/341006	8FT FLOOR FACE	9	20
341005/341007	8FT FLOOR WRAP	9	20
341008/341010	10FT FLOOR FACE	12	22
341009/341011	10FT FLOOR WRAP	12	22

Product Parts for HARDWARE

- 1 - Splash Graphic Face Plates**
- 2 - Soft Case
- 3 - Frame

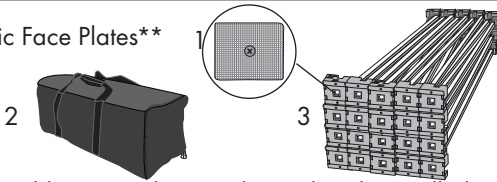

**Frame (3) should come with Face Plates already installed.

Product Parts for FABRIC GRAPHIC (skip to STEP 4)

- 4 - Fabric Graphic Banner

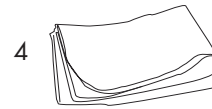

ALL PARTS COME IN THE KIT

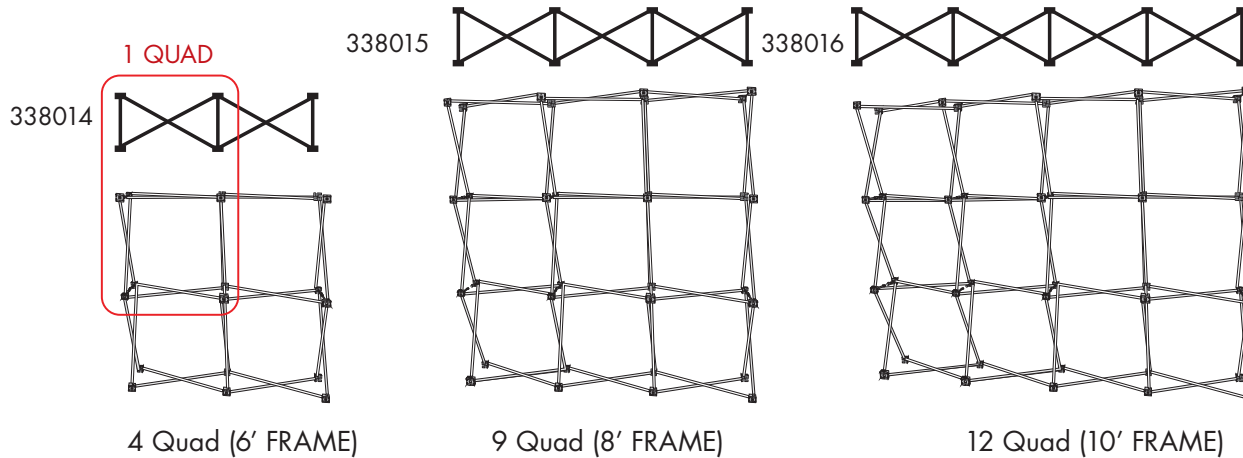

Display Set-Up

Step 1

Remove all parts from your Carry Case and place on a flat, clean surface. Review the Frame (3) and notice where the pivoting light clips are located. This will determine the TOP of the display.

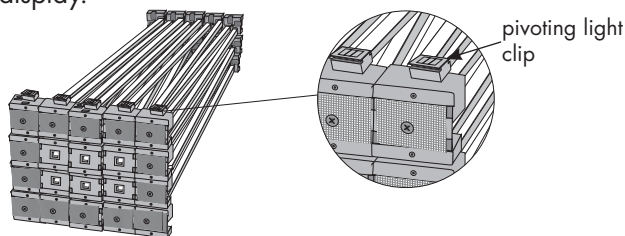

Step 2

Pull the Frame (3) up and out from the corners until it is fully expanded on the floor.

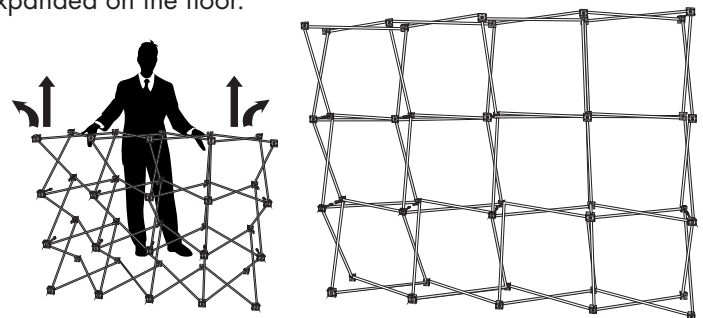

12 Quad (10' FRAME) shown

Display Set-Up Continued...

Step 3

Push all locking clips together to secure the Frame (3) in its expanded position.

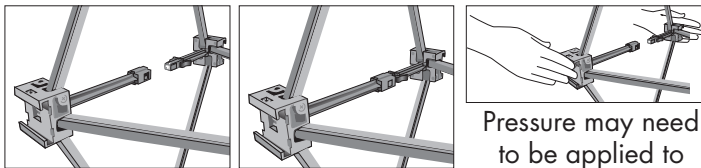

OPEN

CLOSED

Pressure may need to be applied to secure.

Step 5

Graphic is now ready for Display.

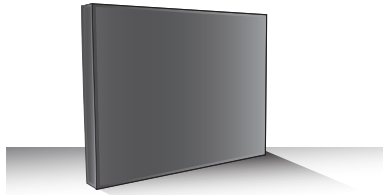

SET-UP NOTE:

Display should have Face Plates (1) already installed in Frame (3). If not, slide (with force) and push the Face Plate (1b) into the hubs. Typically you will slide RIGHT to LEFT when looking at the face of the Frame (3).

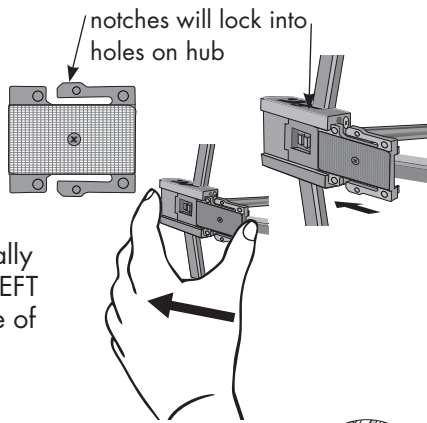

SPLASH FACE GRAPHICS FACE PLATE LOCATION

face plates on all FRONT perimeter hubs only.

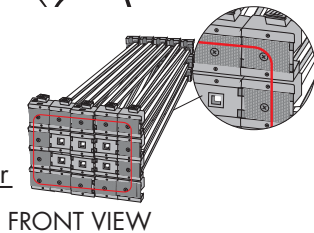

If you have a wrap graphic you will need to slide interlocking face plates (1) into hubs that run on the vertical back ends as well as front perimeter.

SPLASH WRAP GRAPHICS FACE PLATE LOCATION

face plates on all FRONT perimeter hubs AND vertical ends on BACK hubs.

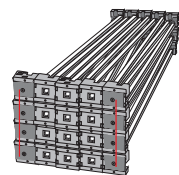

Storage

Place all product parts into Carry Case and store in a cool dry location.



Step 4

Connect the Loop on the Fabric Graphic (4) to the Hook on the Frame (2) starting at the top, working your way to the sides and finally to the bottom.

If you have a wrap graphic, you will need to start at the top backside.

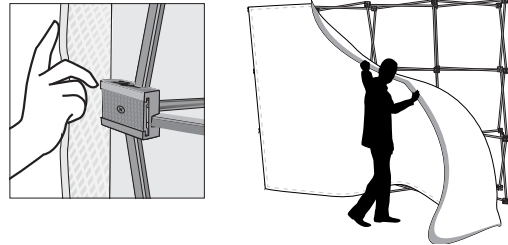

FACE GRAPHIC



WRAP GRAPHIC

SET UP NOTE CONT: Most Graphic Face Plates (1) have arrows and the words "IN" and "OUT" stamped on them **all except the Splash Graphic Face Plate (1)**

**look at the end of the Face Plate. The "OUT" side has 2 bump outs. The "IN" side does not.

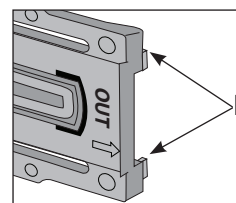

Mural Face Plates shown for reference

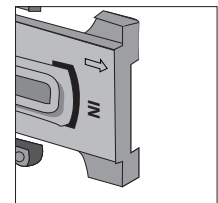

No "bump outs" indicates it is the "IN" side.

Disassembly note:

Repeat steps 4 thru 1 to disassemble. **MAKE SURE ALL LOCKING CLIPS ARE IN OPEN POSITION** before collapsing Frame (1)

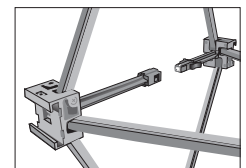

OPEN

Care

Machine wash Cold gentle cycle. Air dry Only. Wrinkles can be steamed out. Do NOT Dry Clean. Do NOT Iron.

Not Recommended to collapse Frame (3) with Fabric Graphic (4) attached. Graphic will wrinkle.