

20'x40' Marquee Tent Instruction

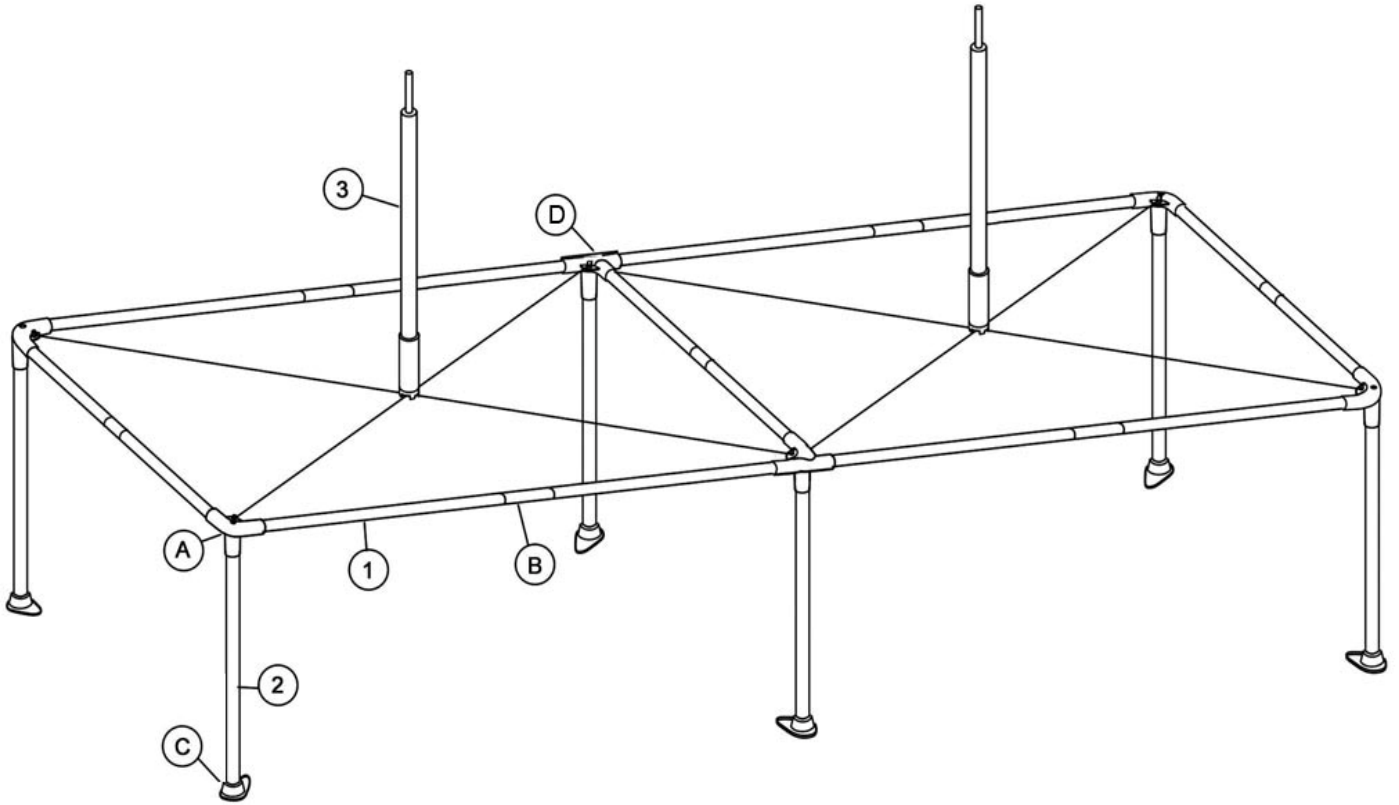
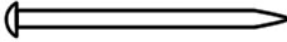
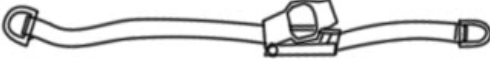
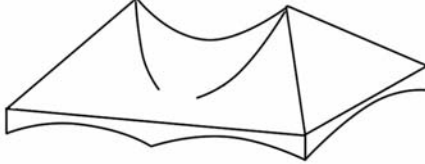
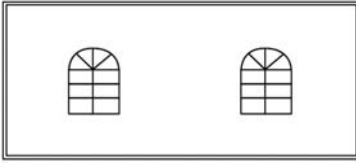
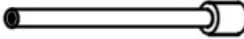

Part No.	Description	Picture	Quantity
1	Eave Pole		14
2	Leg Pole		6
3	Center Pole		2
A	Corner Joint		4
B	Sleeve		7
C	Foot pad		6
D	Center Joint		2
	Cross Cable		4
	Ratchet Rope		6

	Peg		10
	Ratchet Stape		4
	Roof		1
	Sidewall		
	Flag Pole		2

I: Lay all the parts on the ground as shown.

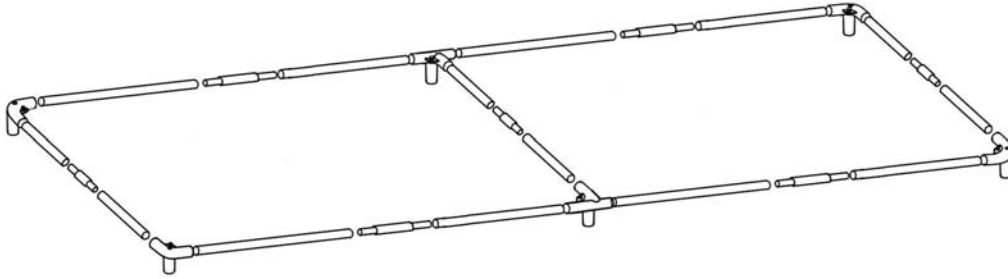

II: Put all the joints and poles together.

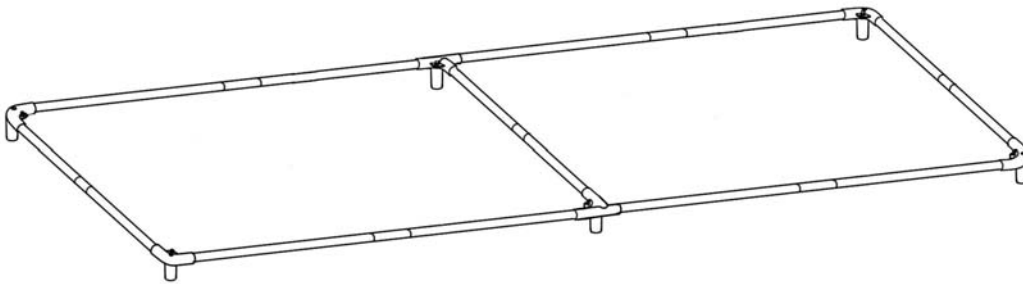

III: Install one cross cable.

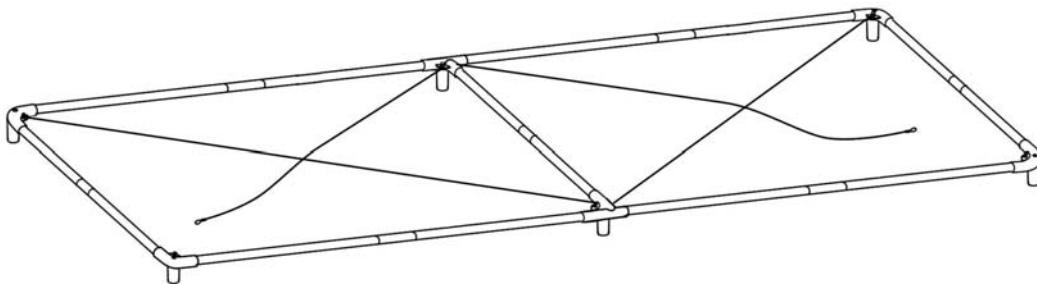

IV: Lift the one corner and suspend another cable.

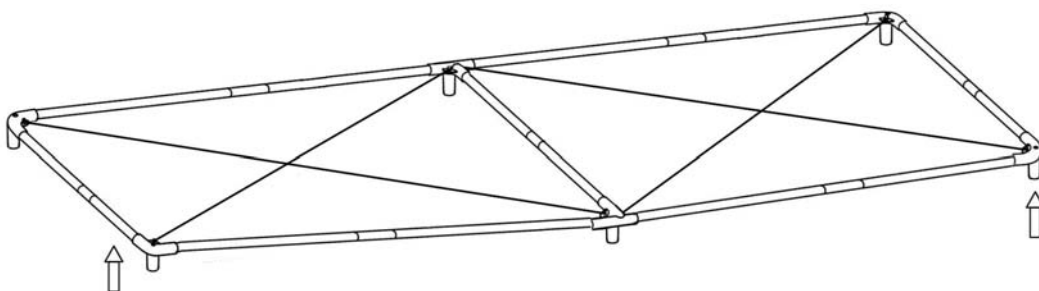

V: Assembly the roof cover, pull the corner with handle.

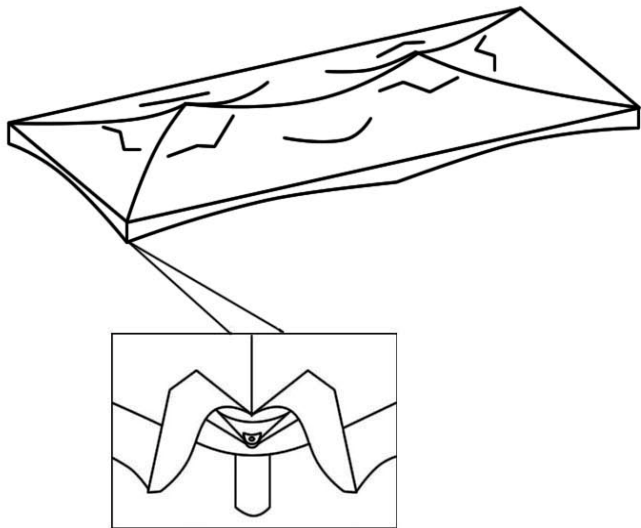

VI: Push the center pole upright.

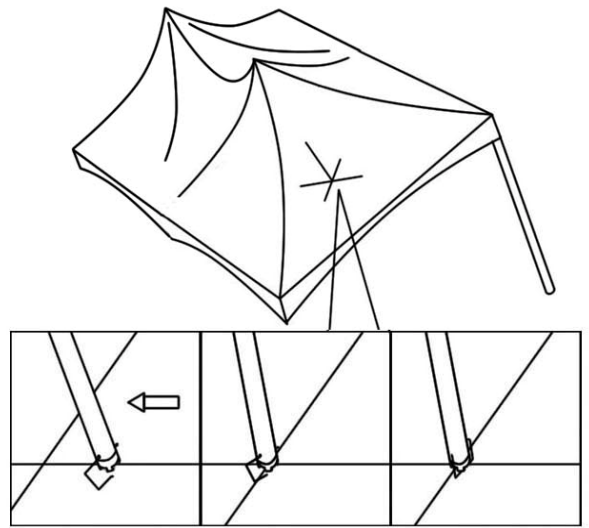

VII: Insert all the legs to make the tent stand up, and then fasten the ratchet ropes.

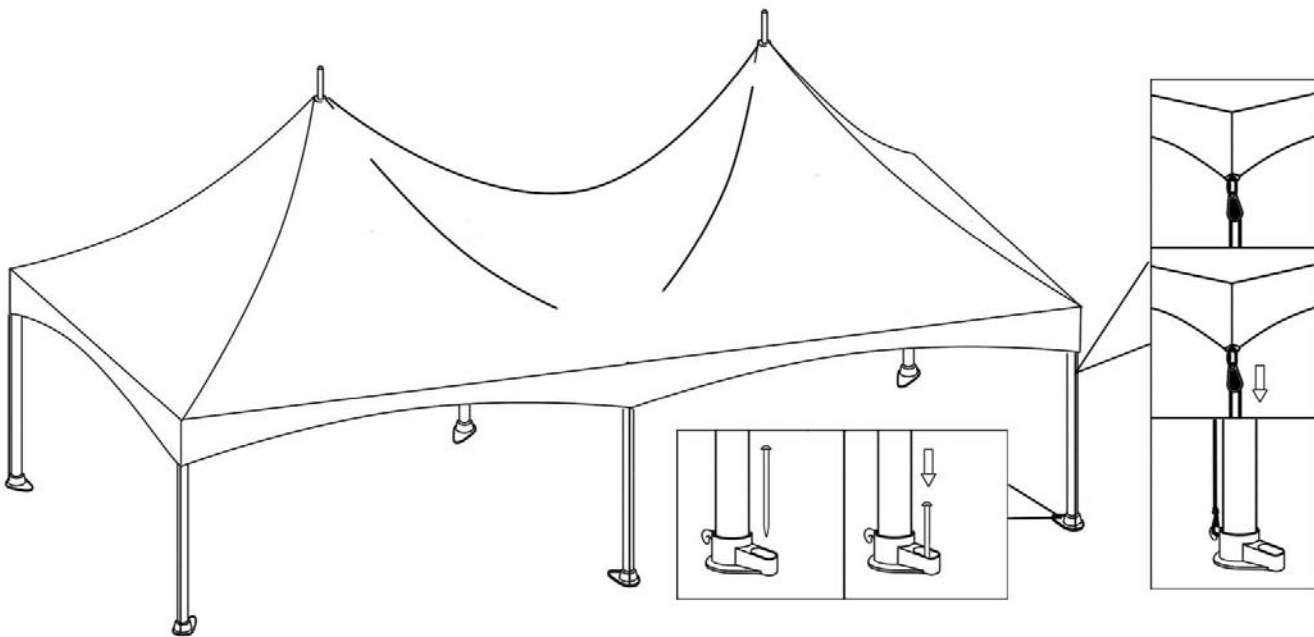

Note: use pegs to fix the tent on the ground

VIII: Hung up all the sidewalls and use the ratchet straps make the tent more stable.

