

HARD TROLLEY CASE

BAGS AND CASES

PRODUCT CODE: #HTCG



20ft EZ Tube shown inside case.
(optional)



PRODUCT DESCRIPTION

The New Hard Trolley Case is an improved alternative to our standard Hard Case. This case still breaks down and forms the base and top of the podium but now a stretch fabric wrap forms the body of the podium. A pull handle and wheels are built into the casing to enable easy transport to and from each show. There is now more interior storage space - enough for a 10' Ready Pop, 10' RPL, and every size of our EZ Tube frames.

DISPLAY DIMENSIONS	36.5"W x 42"H x 22"D
GRAPHIC SIZE	36.5"W x 42"H

GRAPHIC MATERIAL

4 Way Stretch

GRAPHIC FINISHING

2" Loop Velcro on back perimeter

DISPLAY CONSTRUCTION

Aluminum frame, 2" Velcro (hook) strips, and plastic hooks.

SHIPPING WEIGHTS & DIMENSIONS

Shipping Weight	25 lbs (stand only)
	26 lbs (frame and graphic)
Shipping Dimensions	14"L x 22"W x 41"H

LARGE QUANTITY FREIGHT

Freight Shipping	9 boxes per 48"L x 40"W x 69"H skid
Freight Weight	270 lbs (frame only)
	279 lbs (frame & graphic)

GRAPHIC TURN AROUND TIME

2 business days after proof approval

OPTIONAL DISPLAYS (FITS INSIDE CASE)

Ready Pop and RPL (up to 10ft)	EZ Tube Displays (all sizes)
--------------------------------	------------------------------

AVAILABILITY	CA and PA
---------------------	-----------



Wheels built into case for easy transport.

HARD TROLLEY CASE

BAGS AND CASES

PRODUCT CODE: #HTCG

PARTS LIST



Exterior Lid Qty.1



Interior Lid Qty.1



Storage Case Qty.1

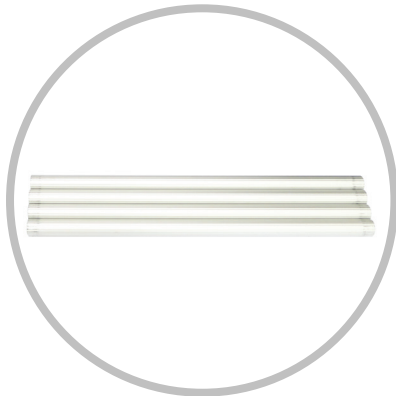

Support Bars Qty.4



Graphic Wrap Qty.1

HARD TROLLEY CASE

SETUP INSTRUCTIONS

1. Open Container

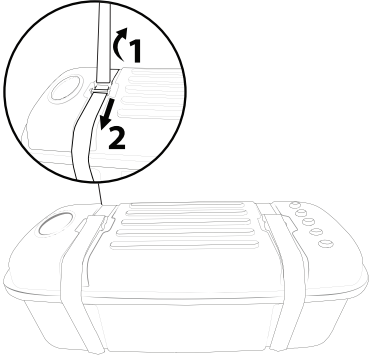

Unfasten straps. (1) Pull up and (2) Pull out in the opposite direction.

2. Remove Items

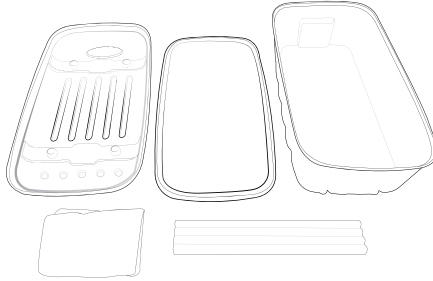

Remove both outside and inside lids. Then remove graphic and poles.

3. Locate Inserts

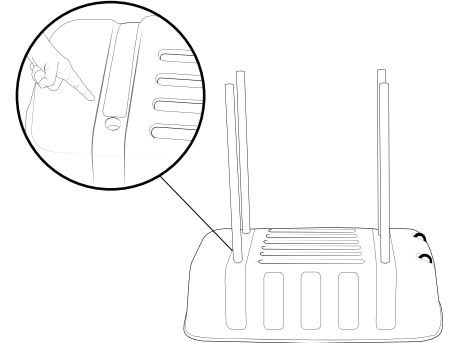

Flip larger case upside down and **locate pole inserts**. Slide all (4) poles into the inserts.

4. Exterior Lid

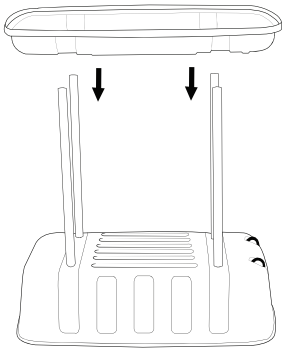

Locate the pole inserts found on the exterior lid. Slide the lid onto the ends of the exposed poles.

5. Drape Graphic

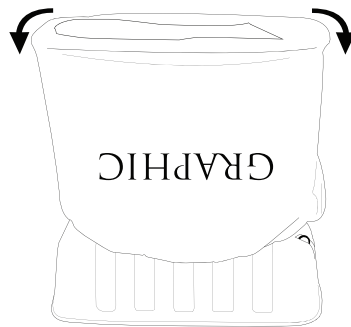

Drape the graphic **upside down** over the top and stretch to outside edges.

6. Cover Podium

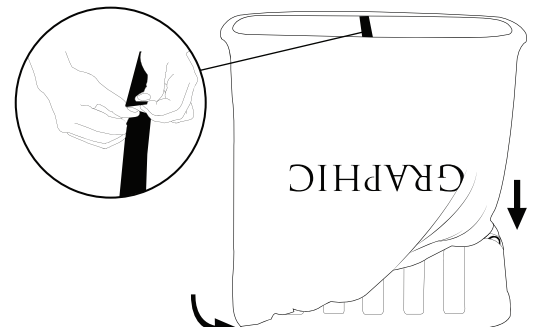

Secure the Velcro strap to maximize tension. Pull the graphic all the way down and tuck the edges into the bottom of the podium.

7. Rotate

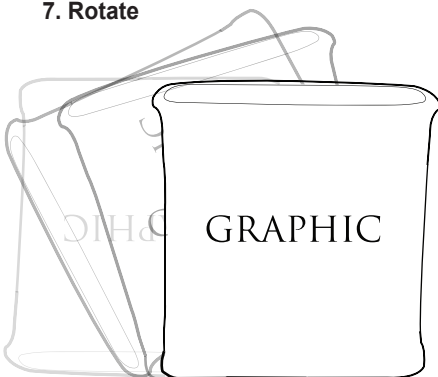

Flip the entire display **right side up**.

8. Finish Graphic Install

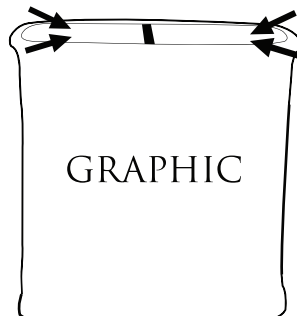

Stretch and pull the graphic in until the edges are covered and the graphic is taut. **Secure the Velcro strap**.

9. Top Lid

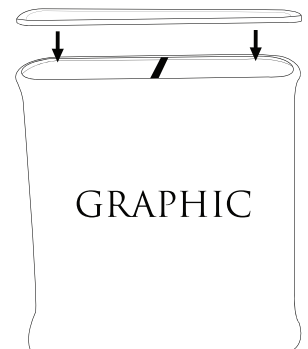

Cover the podium with the top lid to complete the setup process.